

TDE 25 / TDE 65 / TDE 95

EN

INSTRUCTIONS
ELECTRIC HEATER



Table of contents

Information on the use of these instructions 2

Safety 2

Information about the device..... 5

Transport and storage..... 7

Assembly and installation..... 7

Operation 8

Available accessories..... 9

Errors and faults..... 9

Maintenance 10

Technical annex..... 11

Disposal 12

Information on the use of these instructions

Symbols

 **Warning of electrical voltage**
This symbol indicates dangers to the life and health of persons due to electrical voltage.

 **Warning of hot surface**
This symbol indicates dangers to the life and health of persons due to hot surface.

 **Warning**
This signal word indicates a hazard with an average risk level which, if not avoided, can result in serious injury or death.

 **Caution**
This signal word indicates a hazard with a low risk level which, if not avoided, can result in minor or moderate injury.

Notice
This signal word indicates important information (e.g. material damage), but does not indicate hazards.

 **Info**
Information marked with this symbol helps you to carry out your tasks quickly and safely.

 **Follow the manual**
Information marked with this symbol indicates that the instructions must be observed.

You can download the current version of the instructions and the EU declaration of conformity via the following link:

TDE 25



<https://hub.trotec.com/?id=44670>

TDE 65



<https://hub.trotec.com/?id=44671>

TDE 95



<https://hub.trotec.com/?id=44672>

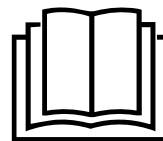

Safety

Read this manual carefully before starting or using the device. Always store the manual in the immediate vicinity of the device or its site of use.

 **Warning**
Read all safety warnings and all instructions. Failure to follow the warnings and instructions may result in electric shock, fire and/or serious injury.
Save all warnings and instructions for future reference.

This appliance can be used by children aged from 8 years and above and persons with reduced physical, sensory or mental capabilities or lack of experience and knowledge if they have been given supervision or instruction concerning use of the appliance in a safe way and understand the hazards involved.

Children shall not play with the appliance. Cleaning and user maintenance shall not be made by children without supervision.



Warning

Children of less than 3 years should be kept away from the device unless continuously supervised.

Children aged from 3 years and less than 8 years shall only switch on/off the appliance provided that it has been placed or installed in its intended normal operating position and they have been given supervision or instruction concerning use of the appliance in a safe way and understand the hazards involved.

Children aged from 3 years and less than 8 years shall not plug in, regulate and clean the appliance or perform user maintenance.



Warning

Do not use the device in small rooms if persons are present who cannot leave the room independently and who are not under constant supervision.



Warning

Do not use mains cables longer than 2 m.

If the mains cable is too long or slips out of the mains connection, there is a risk of electric shock and trip hazard.

Also make sure that the mains connection corresponds to the device and that the earthing must be extended. It is recommended to use a connection constructed in accordance with the national regulations (VDE in Germany).

- Do not use the device in potentially explosive rooms or areas and do not install it there.
- Do not use the device in aggressive atmosphere.
- Place the device in an upright and stable position on horizontal and stable ground.
- Let the device dry out after a wet clean. Do not operate it when wet.
- Do not use the device with wet or damp hands.
- Do not expose the device to directly squirting water.
- Never insert any objects or limbs into the device.
- Do not cover the device during operation.
- Do not remove any safety signs, stickers or labels from the device. Keep all safety signs, stickers and labels in legible condition.
- Do not sit on the device.
- This appliance is not a toy. Keep away from children and animals.
- Check accessories and connection parts for possible damage prior to every use of the device. Do not use any defective devices or device parts.
- Ensure that all electric cables outside of the device are protected from damage (e.g. caused by animals). Never use the device if electric cables or the power connection are damaged!
- Do not leave while the device is in operation: Make sure that the device is switched off. Always remove the mains plug from the mains socket.
- The mains connection must correspond to the specifications in the Technical annex.
- Do not use this heating device in immediate vicinity of swimming pools, bathtubs and showers.
- Insert the mains plug into a properly fused mains socket.
- Observe the device's power input, cable length and intended use when selecting extensions to the power cable. Completely unroll extension cables. Avoid electrical overload.
- Before carrying out maintenance, care or repair work on the device, remove the mains plug from the mains socket. Hold onto the mains plug while doing so.
- Switch the device off and disconnect the power cable from the mains socket when the device is not in use.
- Do not under any circumstances use the device if you detect damages on the mains plug or power cable. If the power cable is damaged, it must be replaced by the manufacturer, its service agent or similarly qualified persons in order to avoid a hazard. Defective power cables pose a serious health risk!
- When positioning the device, observe the minimum distances from walls and other objects as well as the storage and operating conditions specified in the Technical annex.
- Keep a safety distance of at least 1 m between the air inlet and the air outlet of the device and all combustible materials such as textiles, curtains, beds and sofas.
- Make sure that the air inlet and outlet are not obstructed.
- Do not place the device on combustible ground.
- Only use original spare parts, for otherwise safe and functional operation cannot be ensured.
- Allow the device to cool down before transport and/or maintenance work.
- The device must not be positioned directly beneath a wall socket.
- The device must not be used with a programming switch, timer, separate remote control system or similar equipment that switches the device on automatically, as this could cause a fire hazard if the heater is covered or positioned incorrectly.
- Only connect the heating device to a single-phase socket with the mains voltage specified on the nameplate.

- Do not use the device if it has been dropped or if it shows visible signs of damage.
- Do not connect other devices to the same socket as the fan heater.

Intended use

Only use the device for heating closed rooms whilst adhering to the technical data.

Intended use comprises heating the air in:

- Construction trailers
- Greenhouses
- Boathouses
- Garages
- Market stalls
- Workshops
- Gastronomy sector
- Warehouses and halls
- Shipyards
- in wet rooms in compliance with the local or national regulations for the operation of electrical equipment in wet rooms.

Any use other than the intended use is regarded as misuse.

Reasonably foreseeable misuse

- Do not place any objects, e.g. clothing, on the device.
- Do not use this device in the vicinity of fuel, solvents, varnishes or other easily inflammable vapours or in rooms where these substances are stored.
- Never immerse the device in water.
- Do not use the device for heating in vehicles.
- Do not place the device on wet or flooded ground.
- The device may not be exposed to moisture or weather effects (rain, sunlight).
- Do not make any unauthorised modifications, alterations or structural changes to the device.
- Do not use the heating device in immediate vicinity of swimming pools, bathtubs and showers.

Personnel qualification

People who use this device must:









- be aware of the dangers that occur when working with electric devices in damp areas.
- have read and understood the instructions, especially the Safety chapter.

Maintenance tasks which require the housing to be opened must only be carried out by specialist electrical companies or by the manufacturer.

Symbols on the device

Symbols	Meaning
	This symbol located on the device indicates that it is prohibited to place objects (such as towels, clothes etc.) above or directly in front of the device. In order to avoid overheating and fire hazards, the heater must not be covered.

Residual risks

-  **Warning of electrical voltage**
Work on the electrical components must only be carried out by an authorised specialist company!
-  **Warning of electrical voltage**
Before any work on the device, remove the mains plug from the mains socket!
Do not touch the mains plug with wet or damp hands. Hold onto the mains plug while pulling the power cable out of the mains socket.
-  **Warning of hot surface**
Parts of this appliance can become very hot and cause burns. Particular attention is to be paid when there are children or vulnerable persons present!
-  **Warning**
Improper handling entails a risk of burning and electric shock.
Only use the device as intended!
-  **Warning**
Dangers can occur at the device when it is used by untrained people in an unprofessional or improper way!
Observe the personnel qualifications!
-  **Warning**
The device is not a toy and does not belong in the hands of children.
-  **Warning**
Risk of suffocation!
Do not leave the packaging lying around. Children may use it as a dangerous toy.
-  **Warning**
Improper installation entails a risk of fire.
Do not place the device on combustible ground.
Do not place the device on high-pile carpets.
-  **Warning**
In order to avoid overheating and fire hazards, the device must not be covered!

Behaviour in the event of an emergency

1. Switch the device off.
2. Disconnect the device from the mains: Hold onto the mains plug while pulling the power cable out of the mains socket.
3. Do not reconnect a defective device to the mains.

Overheating protection

The device is provided with a safety thermostat which is activated by overheating of the device (when exceeding the operating temperature).

Investigate the cause of overheating.

If the safety thermostat does not switch in the event of overheating, the overheating protection will be tripped.

The device switches off completely (only applies to TDE 25).

The heating coils of the devices are switched off, the fan continues to run (TDE 65 and TDE 95 only).

If so, please contact the customer service to have the overheating protection replaced.

Information about the device

Device description

The device serves to generate and to distribute warm air, for speeding up drying processes and for defrosting frozen materials. It can be used either in closed rooms or in dry outdoor areas.

The heating element generates warmth. The air surrounding the heating element is heated. The heated air is distributed in the room by the fan.

The device is protected against dripping water (IP24). The device is further equipped with an overheating protection.

The device is suitable for tough requirements and therefore suited for the use on construction sites (heating and construction drying), in greenhouses or other commercial areas, e.g. for drying earthenware. Besides, the device is suited for continuous operation.

The device TDE 25 is equipped with a heating level which is activated immediately after connecting the mains plug. The devices TDE 65 and TDE 95 are equipped with a fan stage and three heating levels instead which can be adjusted by means of a selection switch.

Device depiction

TDE 25

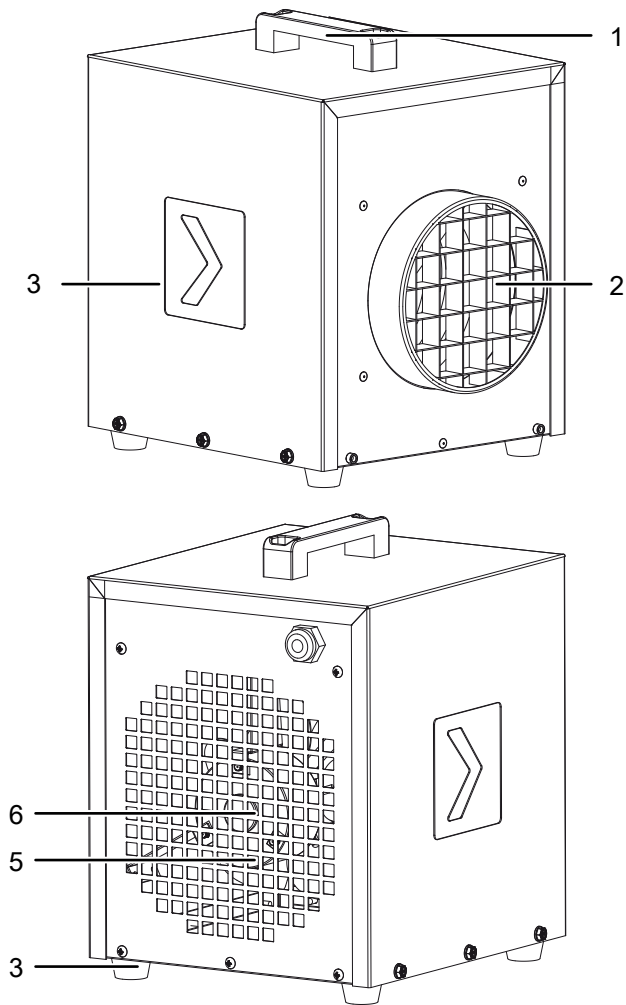

TDE 95 / TDE 65

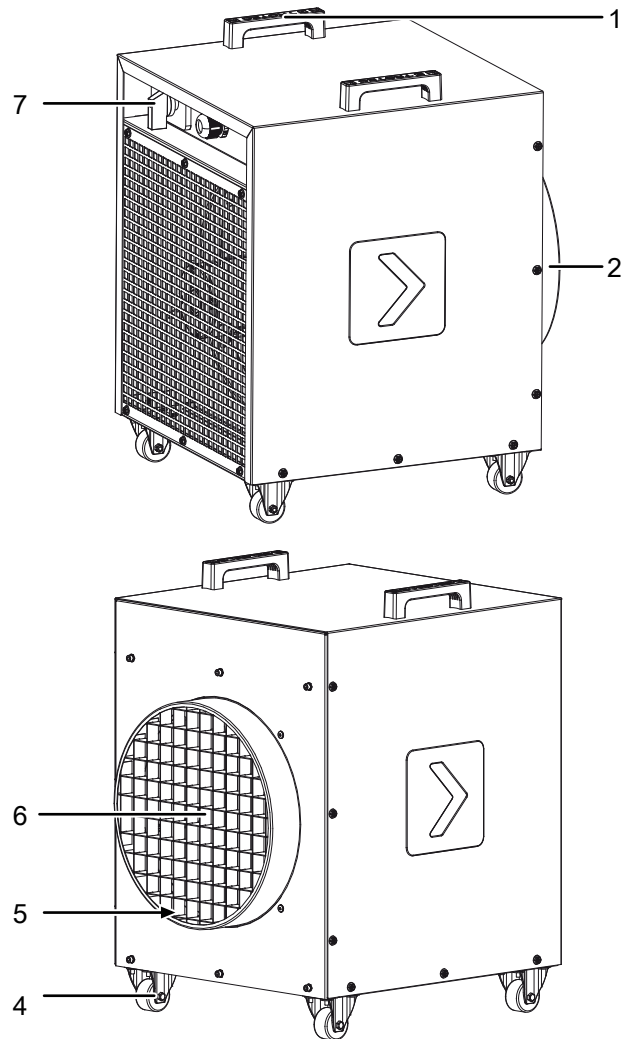

No.	Designation
1	Transport handle
2	Air outlet
3	Foot
4	Wheels
5	Air inlet
6	Fan
7	Selection switch <i>ventilation and heating levels</i>

Transport and storage

Notice

If you store or transport the device improperly, the device may be damaged.

Note the information regarding transport and storage of the device.

Transport

To make the device easier to transport, it is fitted with a carry handle.

Before transporting the device, observe the following:

- Switch the device off.
- Hold onto the mains plug while pulling the power cable out of the mains socket.
- Do not use the power cable to drag the device.
- Allow the device to cool down sufficiently.

Storage

Before storing the device, proceed as follows:

- Hold onto the mains plug while pulling the power cable out of the mains socket.
- Allow the device to cool down sufficiently.

When the device is not being used, observe the following storage conditions:

- Store the device in a dry location and protected from frost and heat.
- Store the device in an upright position where it is protected from dust and direct sunlight.
- If required, use a cover to protect the device from invasive dust.
- Place no further devices or objects on top of the device to prevent it from being damaged.

Assembly and installation

Scope of delivery

- 1 x Device
- 1 x Manual

Unpacking the device

1. Open the cardboard box and take the device out.
2. Completely remove the packaging.
3. Fully unwind the power cable. Make sure that the power cable is not damaged and that you do not damage it during unwinding.

Start-up



Info

Odours might arise upon initial start-up or after a longer period of non-use.

When positioning the device, observe the minimum distance from walls or other objects as described in the chapter Technical annex.

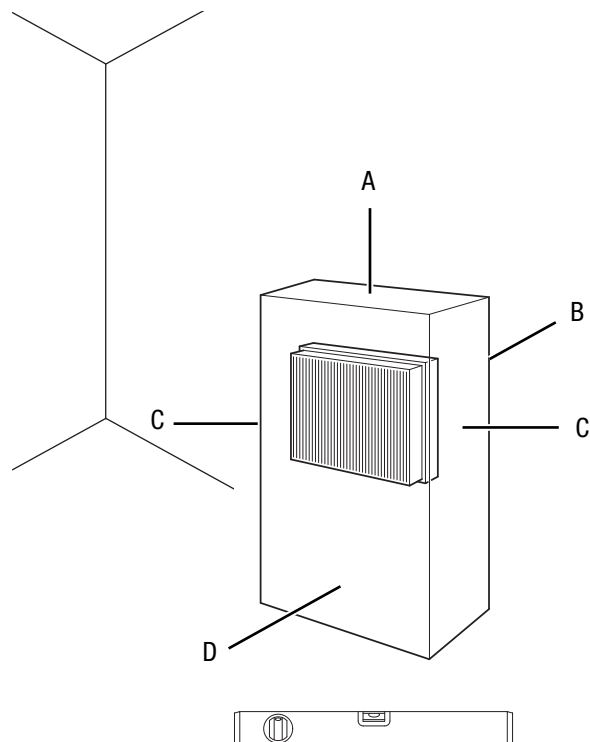

- Before starting the device, check the condition of the power cable. If there are doubts as to their sound condition, contact the customer service.
- The device may only be used in environments with no excessive formation of dust.
- Set the device up in an upright and stable position.

- Do not create tripping hazards when laying the power cable or other electric cables, especially when positioning the device in the middle of the room. Use cable bridges.
- Make sure that extension cables are completely unrolled.
- Make sure that no curtains or other objects interfere with the air flow.
- Make sure that the device cannot come into contact with moisture or water.

Connecting the power cable



Warning

Do not use mains cables longer than 2 m. If the mains cable is too long or slips out of the mains connection, there is a risk of electric shock and trip hazard. Also make sure that the mains connection corresponds to the device and that the earthing must be extended. It is recommended to use a connection constructed in accordance with the national regulations (VDE in Germany).

Notice

Note that the device TDE 25 switches on immediately after connecting the power cable. The devices TDE 65 and TDE 95 only switch on immediately if the selection switch *ventilation and heating levels* (7) is not set to 0.

- Insert the mains plug into a properly fused mains socket.
- Make sure that the power cable is guided along the back of the device. Never guide the power cable along the front of the device!

Operation

- Avoid open doors and windows.

Control panel – TDE 65 / TDE 95

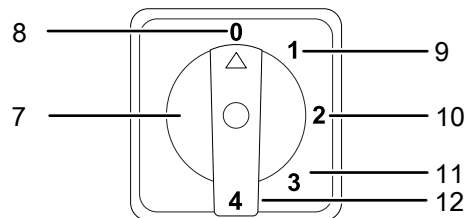

No.	Designation	TDE 65 / 95
7	Selection switch <i>ventilation and heating levels</i>	Switching the device on/off Setting the heating level
8	Position 0	The device is switched off.
9	Position 1	Ventilation (no temperature increase)
10	Position 2	Heating level 50 %
11	Position 3	Heating level 75 %
12	Position 4	Heating level 100 %

Switching the device on

Once you have completely installed the device as described in the chapter Assembly and start-up, you can switch it on.

TDE 65 / TDE 95

1. Set the selection switch *ventilation and heating levels* (7) to the desired position (position 1 – position 4).
⇒ As soon as the room has reached the required temperature, the device stops heating and the fan continues to run. Once the temperature drops again, the device restarts heating. This way, the temperature is kept at a constant level.
2. Set the selection switch *ventilation and heating* (7) to the 0 position to switch the device off again.

TDE 25

1. Insert the mains plug.
⇒ The device is running continuously.
2. Pull out the mains plug to switch the device off again.

Shutdown



Warning of electrical voltage

Do not touch the mains plug with wet or damp hands.

TDE 25

1. Remove the mains plug from the mains socket.
2. Clean the device according to the Maintenance chapter.
3. Store the device according to the Storage chapter.

TDE 65 / TDE 95

1. Set the selection switch *ventilation and heating levels (7)* to position **1 (9)** where ventilation mode only is activated.
2. Keep the fan running until the device has cooled down.
⇒ **Never pull the mains plug from the socket while the fan is running. The device may overheat.**
3. Set the selection switch *ventilation and heating (7)* to **0 (8)** to switch the device off.
4. Remove the mains plug from the mains socket.
5. Disconnect the mains connection, if any.
6. Clean the device according to the Maintenance chapter.
7. Store the device according to the Storage chapter.

Available accessories



Warning

Only use accessories and additional equipment specified in the instructions. Using insertion tools or accessories other than those specified in the instructions may cause a risk of injury.

Designation	Article number
Room thermostat TDE 65/95	6.100.007.011

Errors and faults

The device has been checked for proper functioning several times during production. If malfunctions occur nonetheless, check the device according to the following list.

Notice

Wait for at least 3 minutes after maintenance and repair work. Only then switch the device back on.

The device does not start:

- Check the power connection.
- Check the power cable and mains plug for damage. If you notice damages, do not try to take the device back into operation.

If the supply cord is damaged, it must be replaced by the manufacturer, its service agent or similarly qualified persons in order to avoid a hazard.

- Check the on-site fusing.
- The motor might be defective. Have a defective motor replaced by a specialist electrical company.

The device is switched on, the fan is operating, the heating is not:

- Check whether a heating level is selected.
- Check whether the overheating protection has tripped (see chapter Safety).
- The heating resistor might have blown. Have a defective heating resistor replaced by a specialist electrical company.
- The heating element may be defective. If the heating element is defective, have it replaced by a specialist electrical company.

The fan is not running:

- Check whether the device is switched on.
- Check the power connection.
- Check the power cable and mains plug for damages.
- The fan motor might be defective. Have a defective fan motor replaced by a specialist electrical company.

The air current is reduced:

- Check the air inlet and outlet. Make sure that air inlet and outlet are not obstructed. Remove any dirt. Observe the minimum distance from walls or other objects according to the technical data.

The device is loud or vibrates:

- Check whether the device is set up in a stable and upright position.
- Check the fan for dirt or damages.
- Have the motor checked by an authorised specialist company or by Trotec. There may be a bearing damage on the motor.
- Check the fan blades for dirt and clean them if required (see chapter Maintenance).
- If the fan blades are defective, have them replaced by a specialist company or by Trotec.

The device still does not operate correctly after these checks:

Please contact the customer service. If necessary, bring the device to an authorised specialist electrical company or to the manufacturer for repair.

Maintenance**Activities required before starting maintenance****Warning of electrical voltage**

Do not touch the mains plug with wet or damp hands.

- Switch the device off.
- Hold onto the mains plug while pulling the power cable out of the mains socket.
- Allow the device to cool down completely.

**Warning of electrical voltage**

Tasks which require the device to be opened must only be carried out by authorised specialist companies or by the manufacturer.

Cleaning the housing**Warning of electrical voltage**

Never immerse the device in water!

Clean the housing with a soft, damp and lint-free cloth. Make sure that no moisture enters the housing. Protect electrical components from moisture. Do not use any aggressive cleaning agents such as cleaning sprays, solvents, alcohol-based or abrasive cleaners to dampen the cloth.

Wipe the housing dry after cleaning.

Technical annex
Technical data

Parameter	Value		
Model	TDE 25	TDE 65	TDE 95
Heating capacity	3 kW	0.1/6/9/12 kW	0.1/9/13.5/18 kW
Air flow rate	206 m ³ /h	1094 m ³ /h	1074 m ³ /h
Temperature increase ΔT	43 °C	32 °C	49 °C
Power supply	230 V / 50 Hz	400 V / 50 Hz	400 V / 50 Hz
Nominal current consumption	13 A	18 A	27 A
Recommended fusing	16 A	32 A	32 A
Type of protection	IP24	IP24	IP24
Power consumption	3 kW	12 kW	18 kW
Sound pressure level (distance of 1 m)	65 dB(A)	65 dB(A)	65 dB(A)
Cable length	270 cm	45 cm	45 cm
Dimensions (length x width x height)	340 x 260 x 345 mm	475 x 403 x 582 mm	475 x 403 x 582 mm
Minimum distance to walls and other objects	top (A): 100 cm rear (B): 100 cm sides (C): 100 cm front (D): 100 cm	100 cm 100 cm 100 cm 100 cm	100 cm 100 cm 100 cm 100 cm
Weight	10 kg	27 kg	30 kg

Disposal

Always dispose of packing materials in an environmentally friendly manner and in accordance with the applicable local disposal regulations.



The icon with the crossed-out waste bin on waste electrical or electronic equipment is taken from Directive 2012/19/EU. It states that this device must not be disposed of with the household waste at the end of its life. You will find collection points for free return of waste electrical and electronic equipment in your vicinity. The addresses can be obtained from your municipality or local administration. You can also find out about other return options that apply for many EU countries on the website <https://hub.trotec.com/?id=45090>. Otherwise, please contact an official recycling centre for electronic and electrical equipment authorised for your country.

The separate collection of waste electrical and electronic equipment aims to enable the re-use, recycling and other forms of recovery of waste equipment as well as to prevent negative effects for the environment and human health caused by the disposal of hazardous substances potentially contained in the equipment.

Only for United Kingdom

According to Waste Electrical and Electronic Equipment Regulations 2013 (SI 2013/3113) (as amended) devices that are no longer usable must be collected separately and disposed of in an environmentally friendly manner.

Trotec GmbH

Grebener Str. 7
D-52525 Heinsberg

☎ +49 2452 962-400

☎ +49 2452 962-200

✉ info@trotec.com

www.trotec.com